

# besgo

## VENTILE

- Automatisches Rückspülen
- Automatisches Klarspülen
- Sparschaltung
- Umschalten Schwimmbad – Whirlpool
- Umschalten von 2 Wasserattraktionen
- Umschalten Schwimmbad – Solaranlage

2018



Deutsch Einbau Anleitung

Seiten 2, 3, 14-16

Français Instructions de montage  
VANNES **besgo**

Pages 4, 5, 14

Italiano Istruzioni di montaggio  
per VALVOLE **besgo**

Pagine 6, 7, 14

English Installation Instructions  
**besgo** VALVES

Pages 8, 9, 14

Español Instrucciones de montaje  
de la VALVULA **besgo**

Página 10, 11, 14

Polski Instrukcja instalacji  
ZAWORÓW **besgo**

Strony 12 13, 14

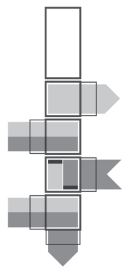

# Installation Instructions for **besgo** VALVES

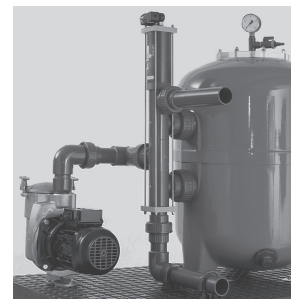

## Installation of the automatic backwash system

All connections to the automatic backwash system can be glued outside (slip connections). The connections leading to the automatic backwash valve should be made using threaded connections or flanges (breakable couplings) and must be installed free from any tension.

Connections:

- A** Filter connection: top
- B** Filter connection: bottom
- C** Connection to filter pump
- D** Connection to backwash pipe
- E** Connection to return water pipe to pool

**Maximum operating:** (from pump)  
**pressure 3,5 bar**

Please ensure that no adhesive gets inside the automatic backwash valve during installation. Incorrect installation can force the piston rod to jam and cause the valve to leak.

### Fitting to the filter

for DN40 / DN50 / DN65

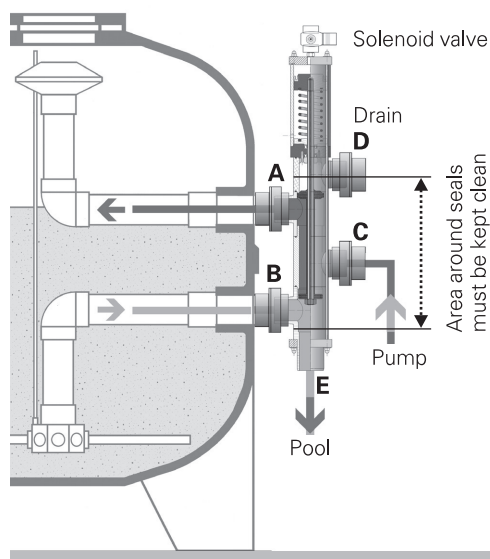

### Mounting besgo on the Wall

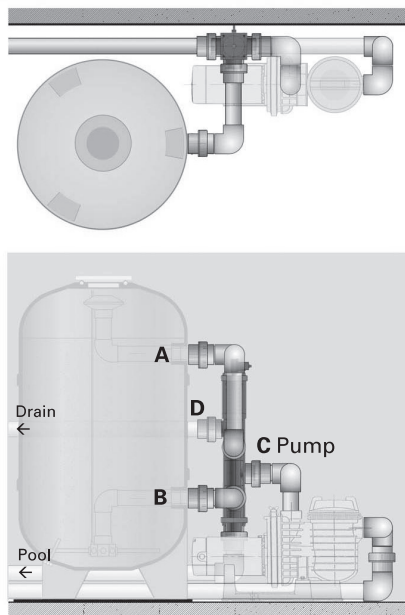

Besgo valves (DN65 / DN80 / DN100 / DN125) should be attached to the wall on site using pipe clamps.

### Changing the direction of connections C and D

If the pipe work is not parallel to the unit, the connection unions **C** and **D** can be rotated through 90 degrees. Additionally a fine adjustment of  $\pm 4^\circ$  is possible. This guarantees an installation free from any tension.

**This is done as follows:**

- a gently loosen the cap nuts on the four drawbars (Z).
- b unscrew one nut and lift the drawbar as high as possible.
- c rotate the corresponding connection pipe. **Attention!** Always remove only one drawbar. Replace drawbar and tighten nut gently. If necessary, adjust another drawbar and continue as stated above.
- d Fasten nut gently with a screwdriver, tightening diagonally, until any gap between both T-pieces disappears. Tighten nuts uniformly and ensure that the O-rings will not be jammed.

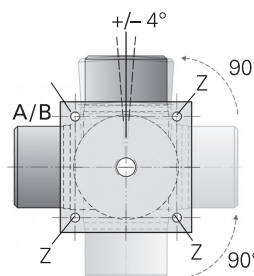

### Possible Positions

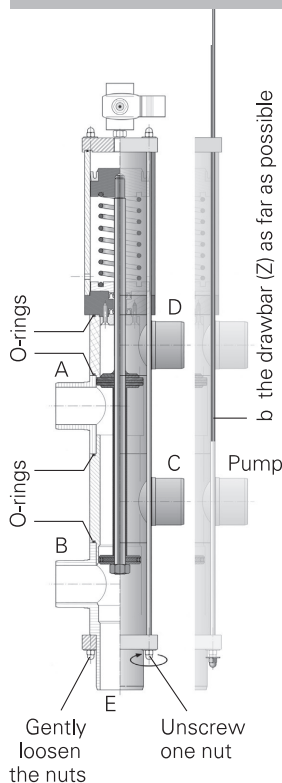
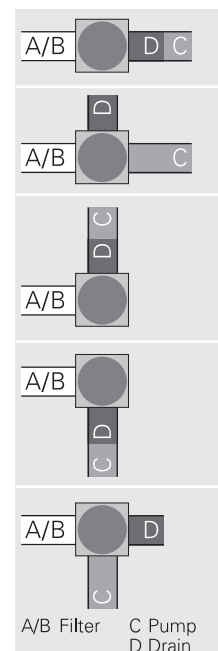

**besgo**  
**VALVES**  
- SIMPLE  
- SAFE

For further information: [www.besgo.ch](http://www.besgo.ch)

# Installation of the three way valve

## ■ Rinsing with additional 3-way valve

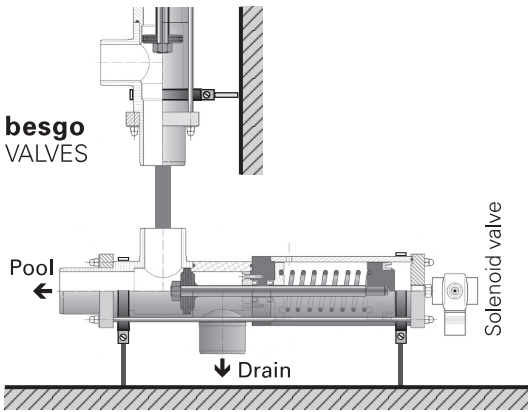

## ■ Energy saving

- 2 from main drain
- 4 pump
- 5 buffer tank
- 6 besgo 3-way valve
- 8 drain

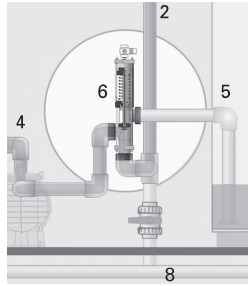

## ■ Switching between two water features

Switch over without switching off!

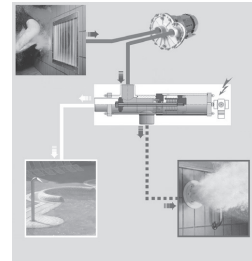

Only one pump and one inlet for two water features

## ■ Switching between pool and whirlpool

In order for the valves to close at the same speed, we recommend operation with compressed air

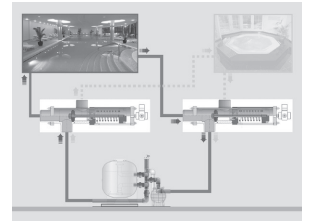

Only one filter, one pump, one water treatment  
Switch over without switching off!

# Connection of the Solenoid Valve

**besgo VALVES** are pneumatic valves. They can be operated with water or air pressure.

**The operating pressure should lie between 3.5 - 6.0 bar.**

### Operation with water pressure (with pressure line PL, on site):

If the pressure of the water supply (mains pressure) is high enough, this pressure is totally suitable as the motive power needed to operate the valve. We recommend the **installation of a pre-filter** to protect the solenoid valve against dirt. A dirty solenoid valve can become blocked and this can lead to a malfunction.

If other devices (e.g. level controller) are connected to the same water circuit, a non-return valve must be fitted. When closing the valve, the water, which flows out from connection R1, can be channeled into the drain by means of a suitable tube. Please observe the regulations of your local water authority.

### Operation with air pressure:

If the water pressure is too low, we recommend operation of the valves with air pressure. Small economical air compressors with tanks (min. 20 litre) are suitable. The valves operate considerably faster with air pressure than with water pressure.

**Tip:** The operation of the compressor can be limited to daytime hours by means of a time clock.



Compressor on site

## A practical tip

The non-return valve prevents pressure drop or suction if another device is connected to the same line.

### For example:

whilst backwashing, the top-up of the overflow tank could be initiated. Without a non-return valve this could result in a pressure drop in the besgo valve which would cause the backwashing to stop immediately.

## Installation: DN40/d50, DN50/d63, DN65/d75, DN80/d90, DN100/d110, DN125/d140

Included is a 3/2-way solenoid valve (230 V) with emergency manual operation and 2 x 1/4" connections and 1 x 1/8" connection.

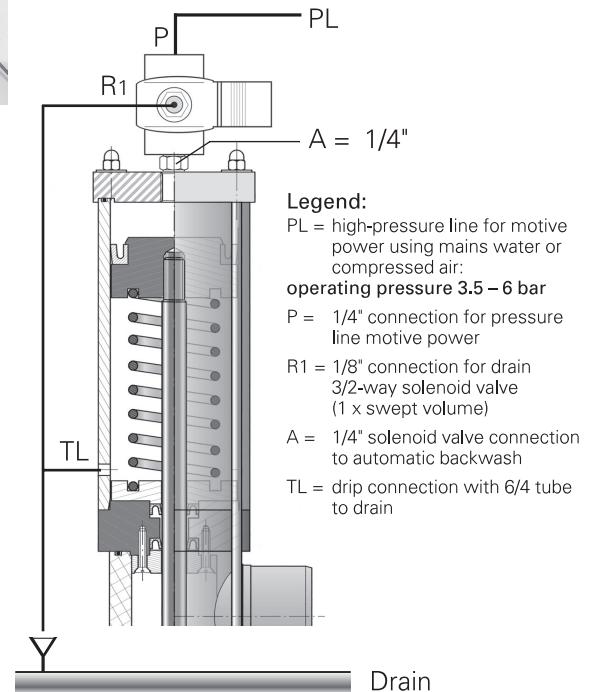
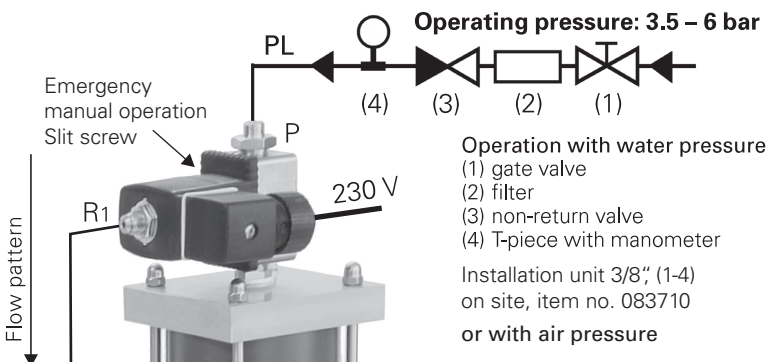

## Emergency manual operation (for use by qualified service personnel only)

This is used for checking the correct operation of the besgo. Manual operation will trigger backwashing without automatic control. To initiate manual backwashing, the slotted screw must be turned 90° clockwise in the «backwashing».

The slit screw must be placed in the «Filter» position after backwashing, otherwise the pool will be emptied.

Slit screw «Filter» position

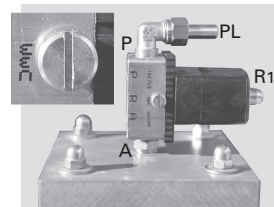

Slit screw «Backwash» position

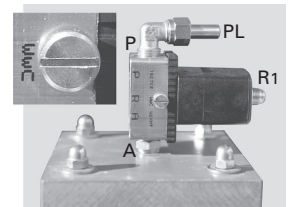

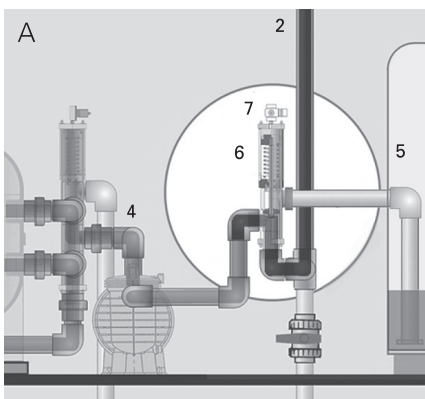
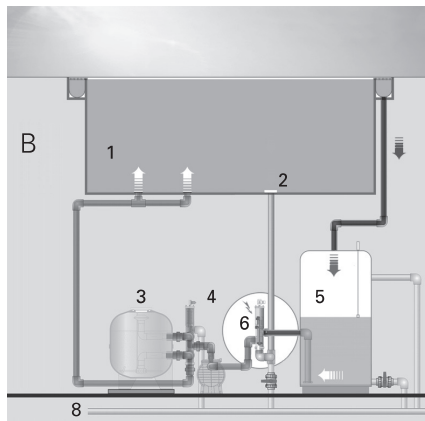
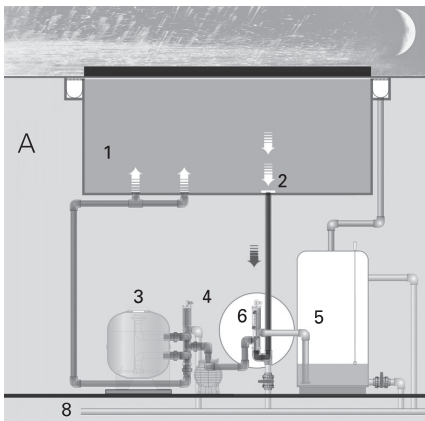

DE

Energie und Kosten sparen mit besgo 3-Wege-Ventil

■ Sparschaltung

**Legende:**  
 1 Schwimmbad  
 2 Bodenablauf  
 3 Filter  
 4 Pumpe  
 5 Schwallwasserbehälter  
 6 besgo 3-Wege-Ventil  
 7 Magnetventil (Ohne Strom – Sparschaltung)  
 8 Kanal

Nur für Schwimmbecken mit Überlaufrinne

**A** Sparschaltung Umwälzung über Bodenablauf  
**B** Normalschaltung Umwälzung über Rinne

FR

Économiser de l'énergie et des coûts grâce à la vanne à trois voies besgo

■ Circuit économiseur

**Légende :**  
 1 piscine  
 2 siphon  
 3 filtre  
 4 pompe  
 5 réservoir d'eau refoulee  
 6 vanne à trois voies besgo  
 7 vanne magnétique (sans courant, circuit économiseur)  
 8 égout

Uniquement pour piscines pourvues de goulotte de débordement

**A** Circuit économiseur  
 Circulation à travers le siphon  
**B** Commutation normale  
 Circulation à travers la goulotte

IT

Risparmio d'energia e di costi con valvole a 3 vie besgo

■ Commutazione di risparmio

**Leggenda:**  
 1 piscina  
 2 scarico di fondo  
 3 filtro  
 4 pompa  
 5 vasca di compenso  
 6 valvola a 3 vie besgo  
 7 valvola magnetica (senza corrente di risparmio)  
 8 canalizzazione

Soltanto per piscine a sfioro

**A** Commutazione di risparmio tramite scarico  
**B** Commutazione normale tramite sfioro

ES

Ahorro energético, y económico con la válvula besgo de 3-vías

■ Posición modo ahorro

**Legenda :**  
 1 piscina  
 2 sumidero  
 3 filtro  
 4 bomba  
 5 depósito de compensación  
 6 válvula Besgo de 3-vías  
 7 electroválvula (no necesita corriente por modo ahorro)  
 8 desagüe

Sólo para piscinas con rebosadero perimetral

**A** Funcionamiento modo "ahorro"  
**B** Funcionamiento a través del rebosadero

EN

Save energy and money with the besgo 3-way valve

■ Energy saving

**Legend:**  
 1 pool  
 2 main drain  
 3 filter  
 4 pump  
 5 buffer tank  
 6 besgo 3-way valve  
 7 solenoid valve (no current necessary during energy saving)  
 8 drain

Only suitable for overflow pools.

**A** Energy saving (main drain)  
**B** Normal operation (overflow tank)

PL

Ószczędność energii i pieniędzy z 3-drogowym zaworem besgo

■ Oszczędność energii

**Legenda:**  
 1 basen  
 2 odpływ denny  
 3 filtr  
 4 pompa  
 5 zbiornik przelewowy  
 6 3-drogowy zawór besgo  
 7 elektrozawór (nie potrzebuje prądu w czasie oszczędzania energii)  
 8 odpływ

Przeznaczony tylko do basenów przelewowych.

**A** Oszczędność energii (odpływ denny)  
**B** Praca normalna (odpływ przez przelew)

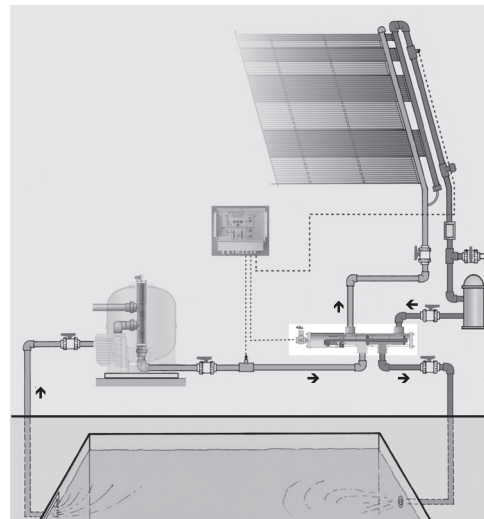

Weitere Anwendung mit besgo VENTIL

■ Mit 4-Wege-Ventil – autom. Umschalten von Schwimmbad – Solaranlage

Autre application aux VANNE besgo

■ Grâce à la vanne à 4 voies – inversion automatique de piscine – système solaire

Altre applicazioni con VALVOLE besgo

■ Con valvola autom. a 4 vie – commutazione autom. piscina – impianto solare

Other possibilities with besgo VALVE

■ With 4-way valve, automatic switchover of solar heating

Altre applicazioni con VALVOLE besgo

■ Con valvola autom. a 4 vie – commutazione autom. piscina – impianto solare

Inne możliwości z zaworem besgo

■ Automatyczne przełączanie ogrzewania solarnego z zaworem 4-drogowym

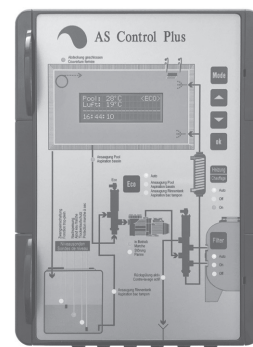

Steuerung:  
 Commande:  
 Quadro di comando:  
 Control:  
 Cuadro de control:  
 Sterowanie:

**AS Control Plus**